

# DACHNAYA STRELKA

## (2020)

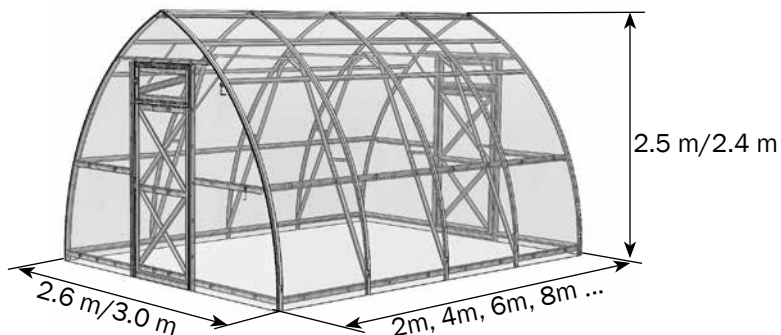

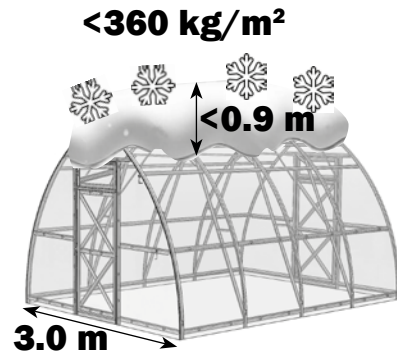

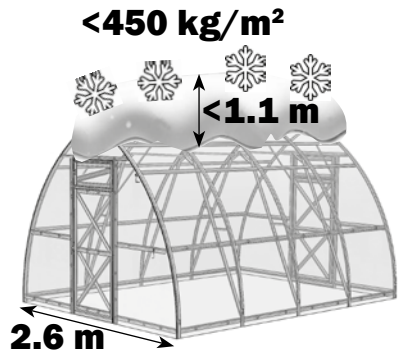
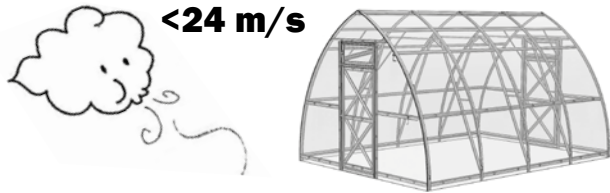
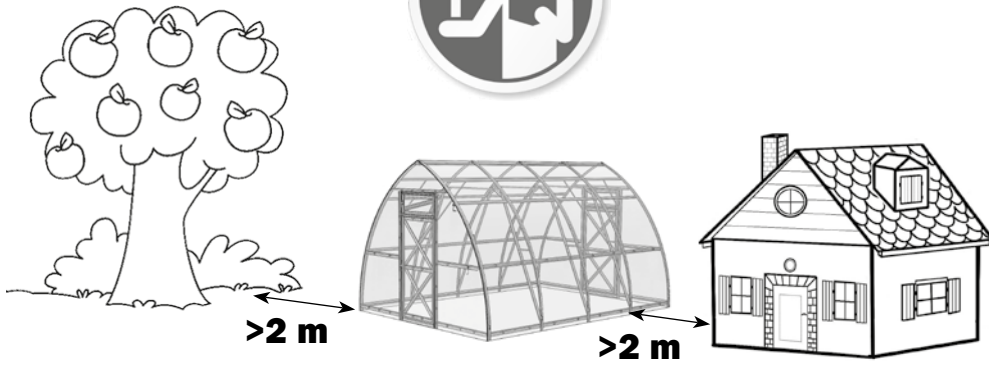





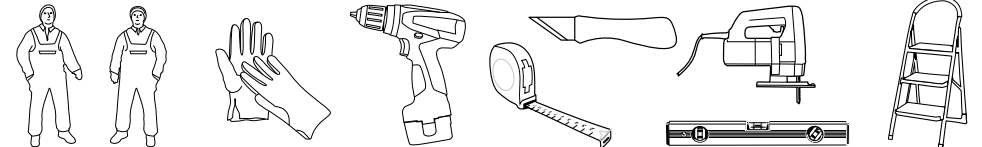

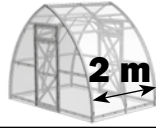



































**24x**











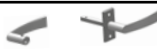
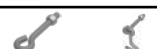







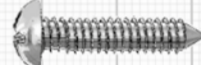





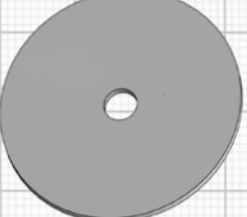

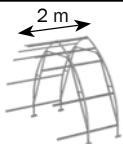



		<b>S</b>		
		<b>L</b>		
<b>2 m</b>	0	5.2 m <sup>2</sup>	6 m <sup>2</sup>	x 2
<b>4 m</b>	x 1	10.4 m <sup>2</sup>	12 m <sup>2</sup>	x 3
<b>6 m</b>	x 2	15.6 m <sup>2</sup>	18 m <sup>2</sup>	x 4
<b>8 m</b>	x 3	20.8 m <sup>2</sup>	24 m <sup>2</sup>	x 5
<b>10 m</b>	x 4	26 m <sup>2</sup>	30 m <sup>2</sup>	x 6









				
№1				
1		0.96 m	x 20	
2		0.9 m	x 4	
3		0.97 m	x 4	
4		0.67 m	x 4	
5		0.31 m	x 2	
6		0.31 m	x 2	
7		0.68 m	x 2	
№2				
8		1.5 m	x 6	
9		1.5 m	x 6	
10		1.5 m	x 4	
11		1.49 m	x 2	
12		1.49 m	x 2	
№3				
13		0.35 m	x 10	
14		0.2 m	x 10	
15		3 m 2.6 m	1.22 m 1.28 m	x 2
16		3 m 2.6 m	0.82 m	x 2 x 6
17		3 m 2.6 m	1.02 m	x 4 -
18		0.47 m	x 4	
19		3 m 2.6 m	1.27 m 1.20 m	x 1
20		1.06 m	x 4	
21		0.3	x 4	

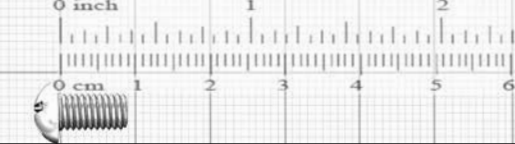

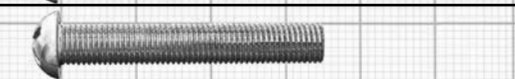
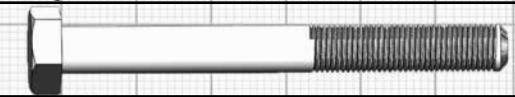
22		0.25	x 2	
23		0.67	x 6	
24		0.25	x 2	
25		3 M 2.6 M	0.86 0.72	x 4
26		3 M 2.6 M	0.74 0.81	x 4
№4				
27		1.14	x 2	
28		0.78	x 2	
29		0.73	x 2	
30		0.73	x 2	
31		0.78	x 2	
32		0.82	x 4	
33		0.37	x 2	
34		0.37	x 2	
№5				
35		12	x 1	
№6				
36			x 8	
37			x 3	
38			x 12	
39			x 4	
40			x 16	
41			x 3	
42			x 6	
43			x 4	
44			x 8	

45			x 4
46			x 4
47			x 1
48	M4x8		x 6
49	M5x10		x 322
50	M5x14		x 114
51	M5x12		x 80
52	M5x35		x 86
53	M6x60		x 6
54	4.8x22		x 14
55	M4		x 6
56	M5		x 612
57	M6		x 6
58	6		x 12
59	10		x 8
60	32x5		x 98

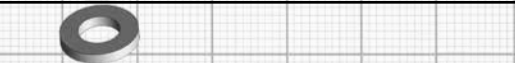
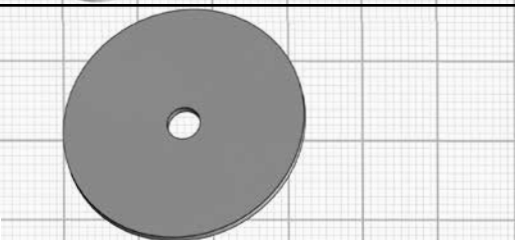
				
<b>№1</b>				
1		0.96 m	x 20	
<b>№2</b>				
2		1.5 m	x 4	
3		1.5 m	x 4	
4		0.35 m	x 4	
5		0.2 m	x 4	
6		3 m 2.6 m	1.27 m 1.20 m	x 2
7		1.06 m	x 8	
8		0.25 m	x 4	
9		0.25 m	x 4	
<b>№3</b>				
10		1.14 m	x 2	
<b>№4</b>				
11			x 2	
12			x 2	
13			x 4	



14	M4x8		x 4
15	M5x10		x 180
16	M5x14		x 4
17	M5x35		x 16
18	M6x60		x 4
19	M4		x 4
20	M5		x 200
21	M6		x 4
22	6		x 8
23	32x5		x 16

# 1

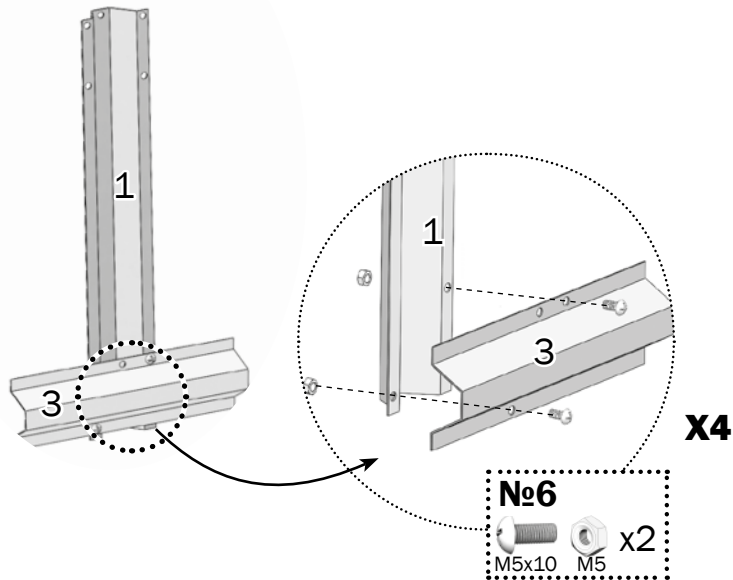
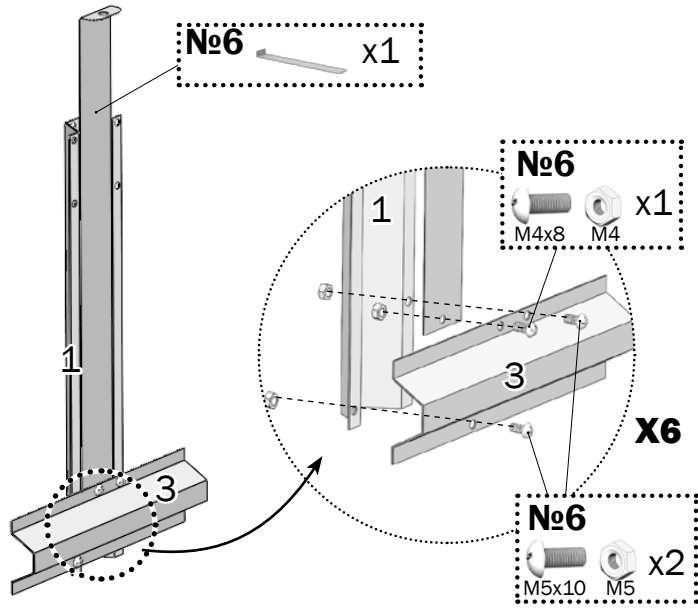
№3  x1    №3  x1



# 2.1

№2  x2    №3  x1

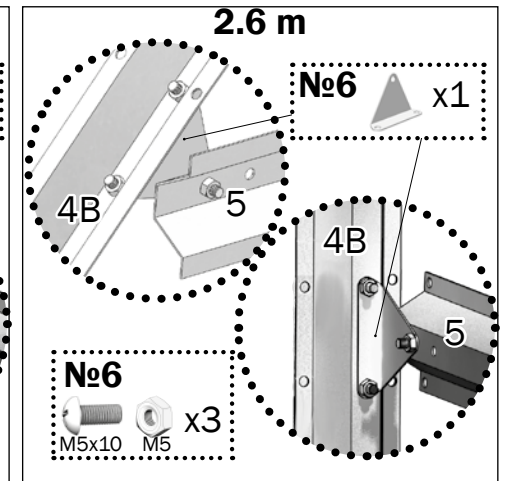
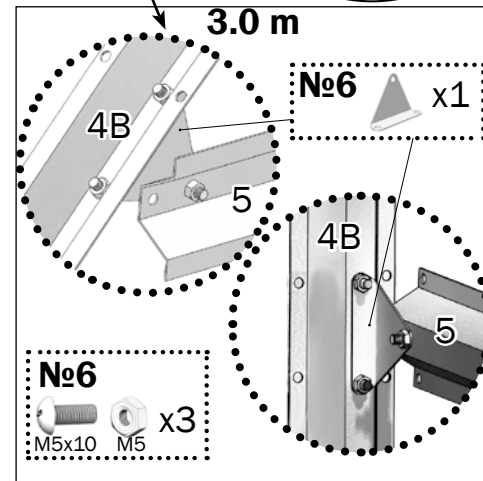
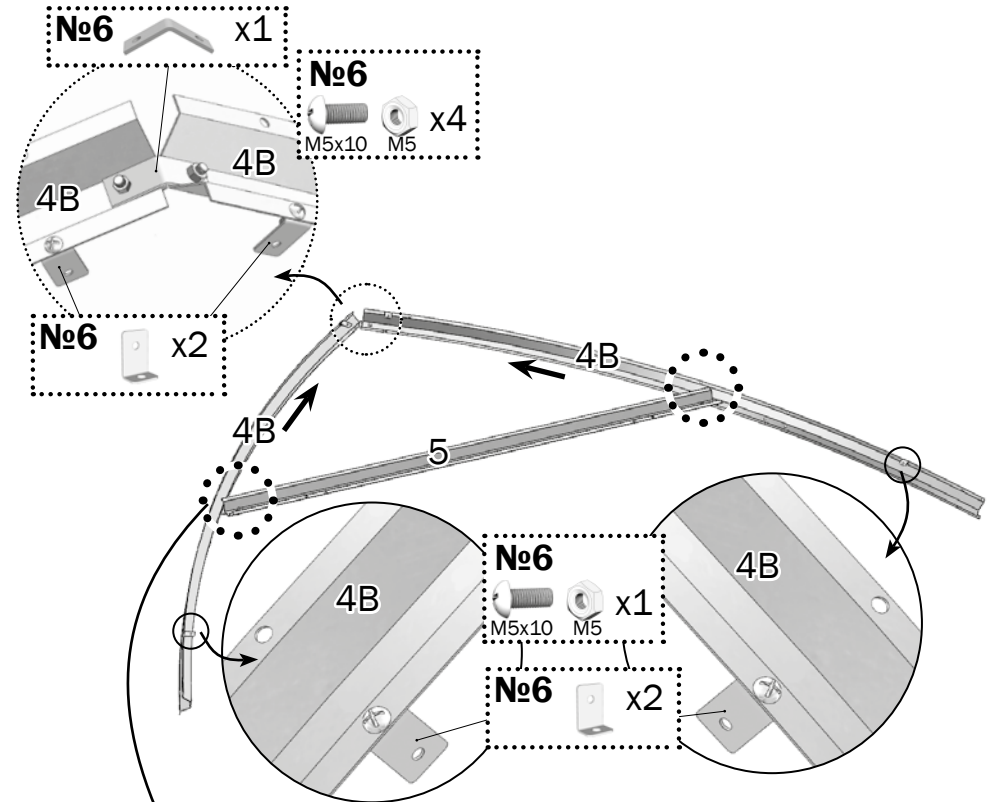



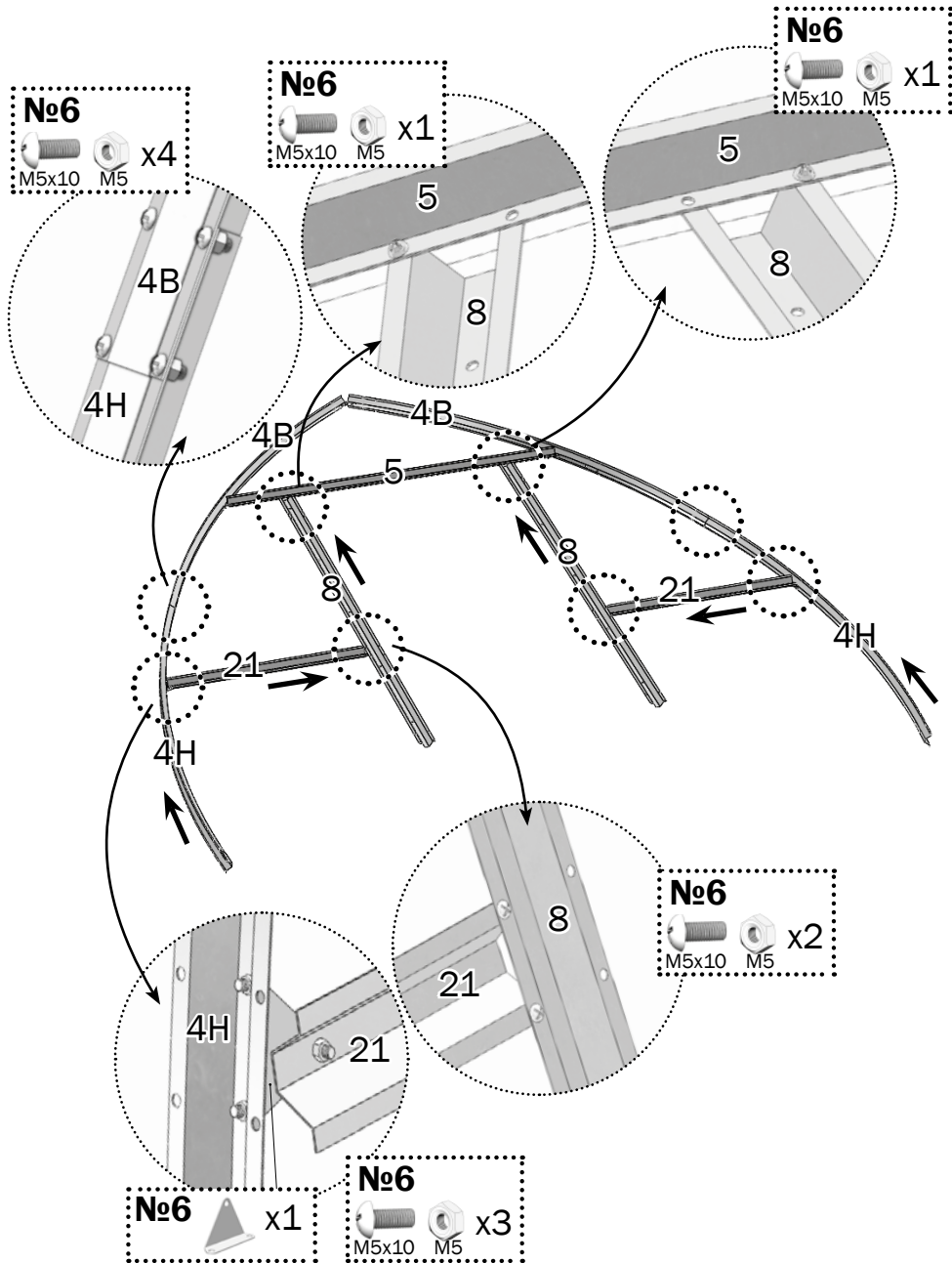

# 2.2

- No2  x2
- No3  x2
- No2  x2



# 2.3

- No3  x4
- 2.6 m No3  x3
- 3.0 m No3  x2
- No3  x1

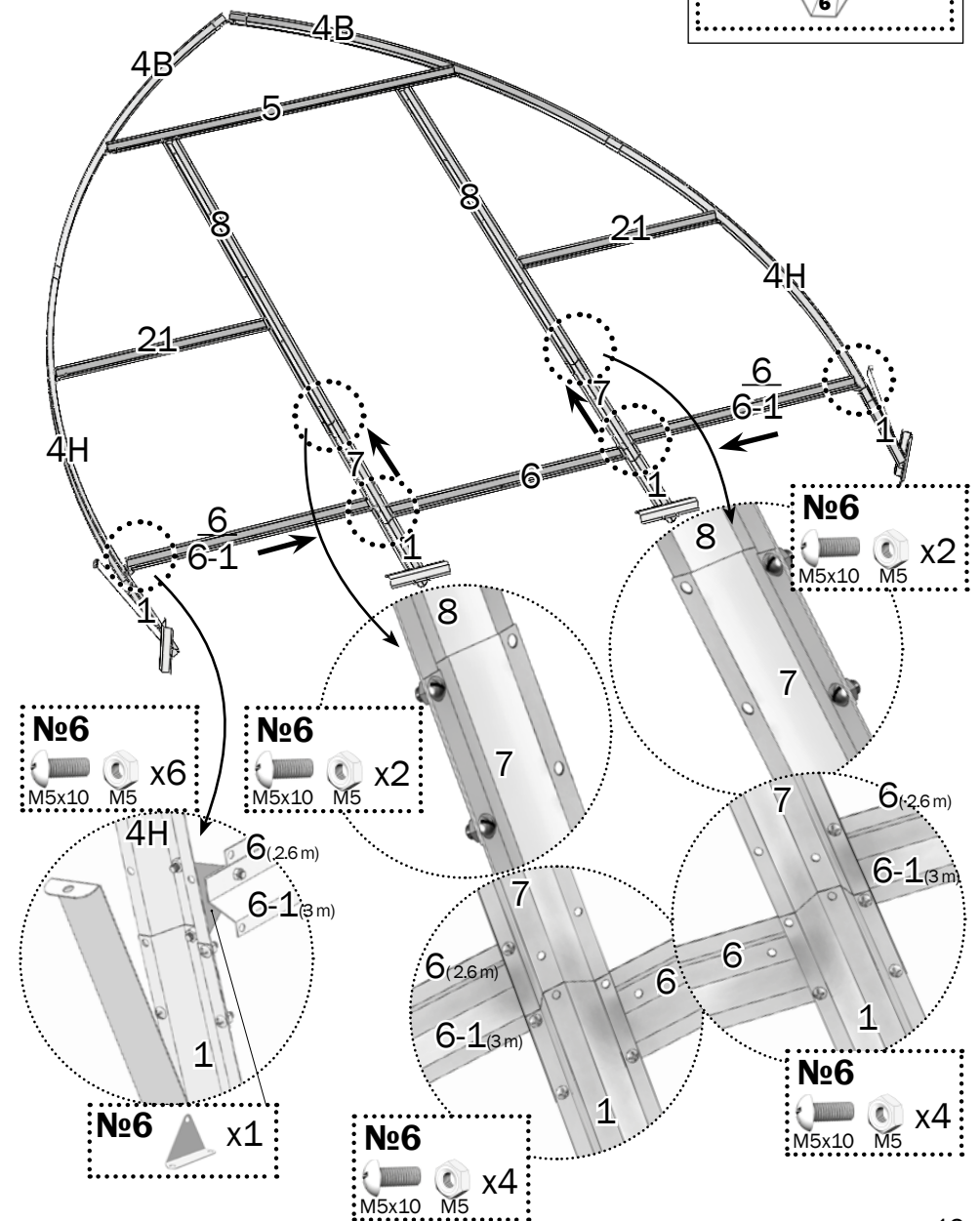

# 3.1

- No2 4H x2
- No2 4B x2

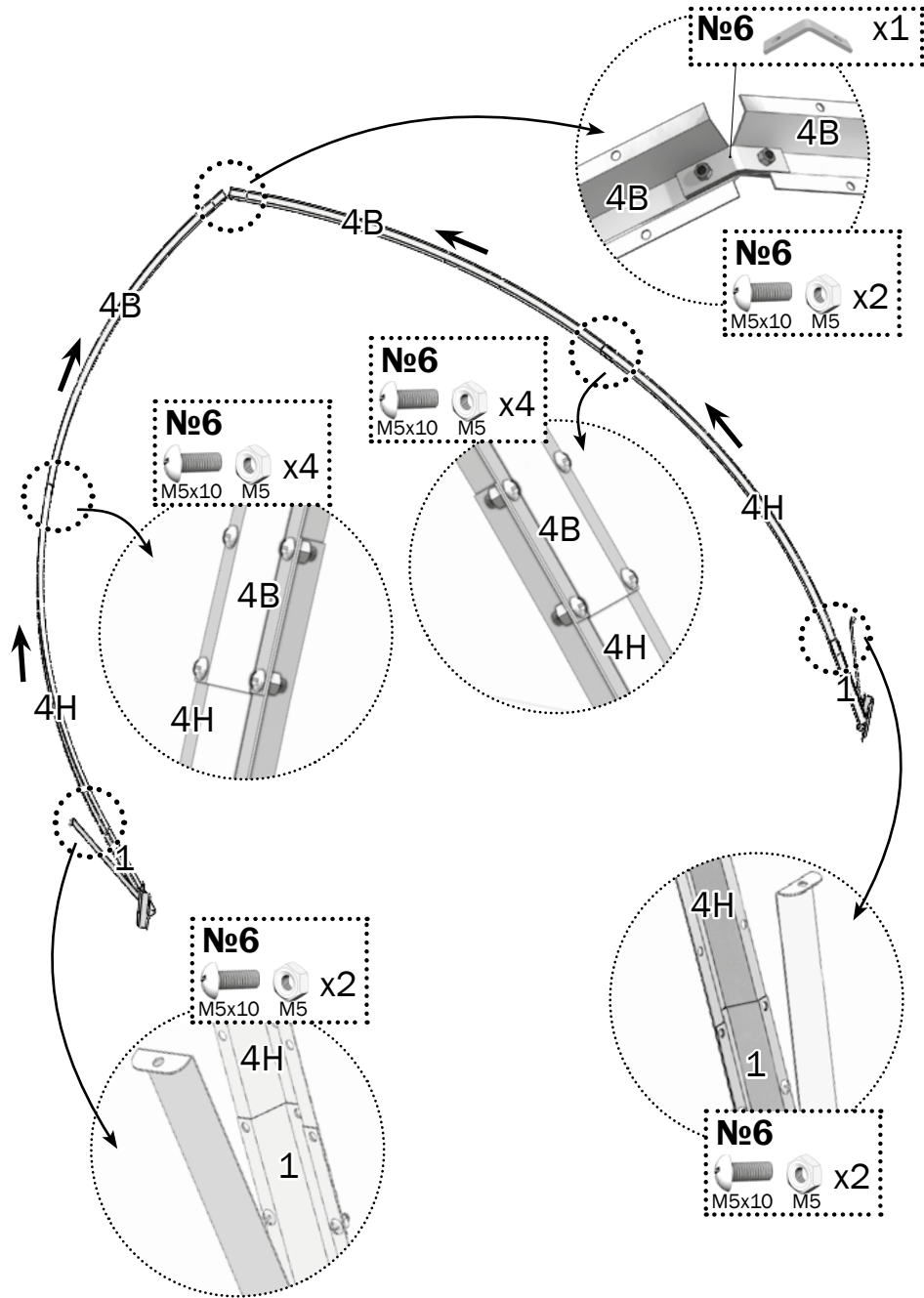

# 3.2

- No3 18 x2
- No3 10 x4
- No3 9 x1
- No3 11 x2

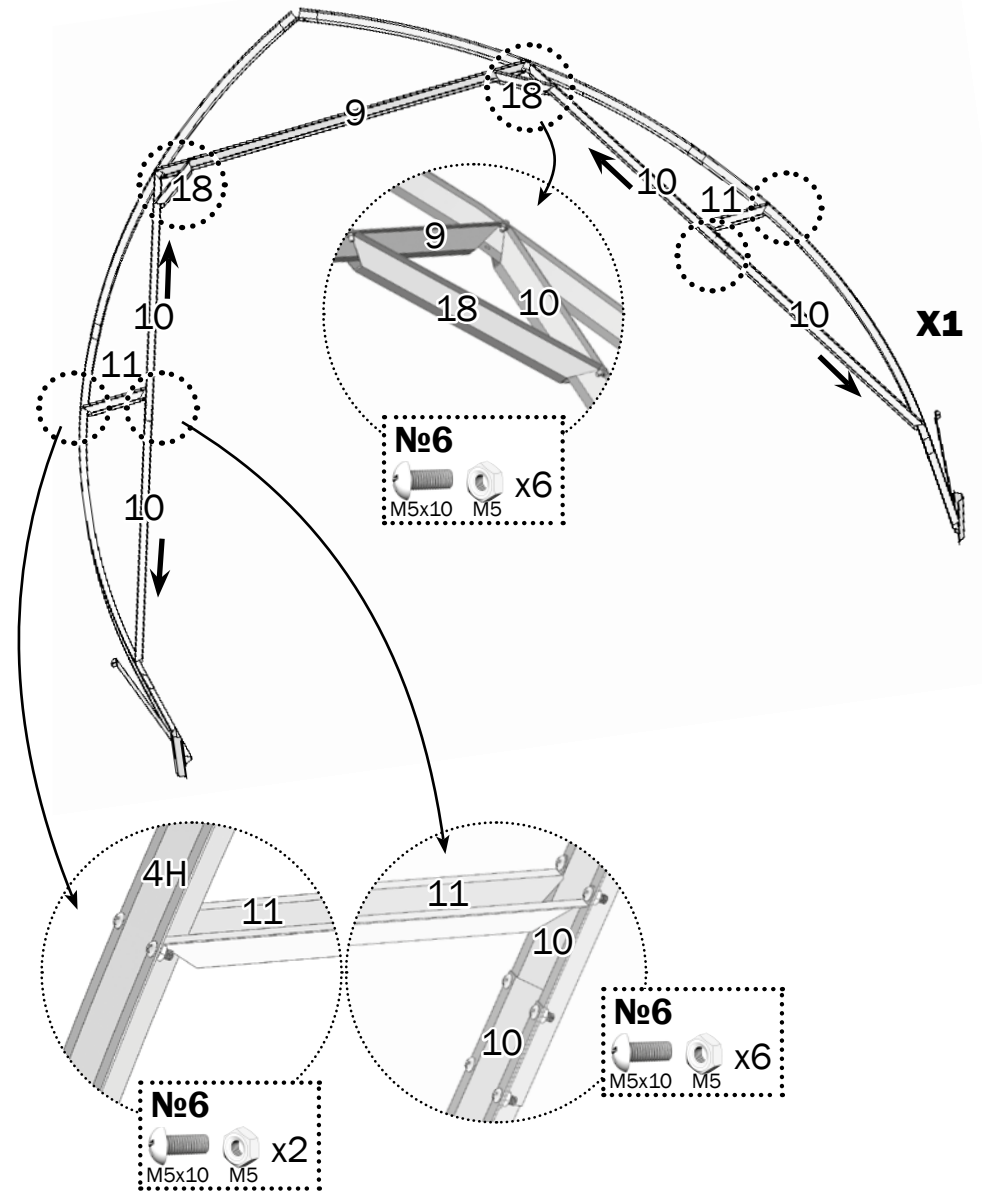



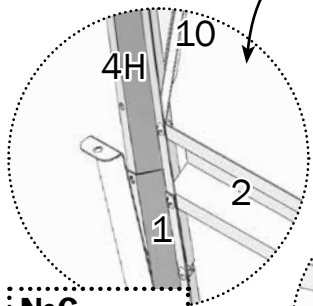
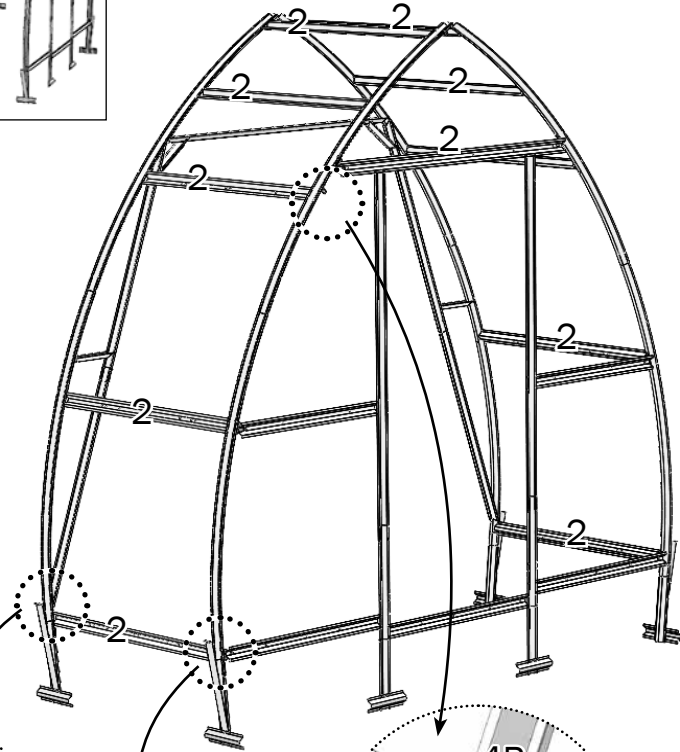
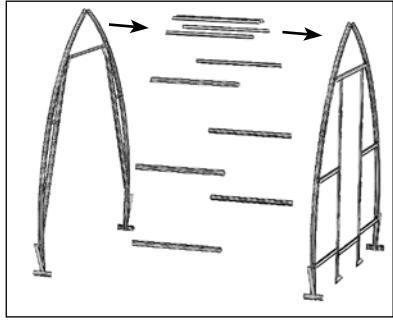

# 4.1

No1  x10



No6   x2  
M5x10 M5

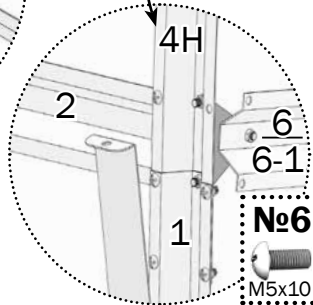

No6   x2  
M5x10 M5

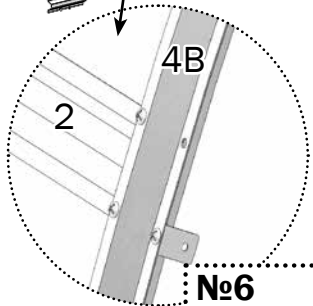

No6   x2  
M5x10 M5

# 4.2

No1  x10

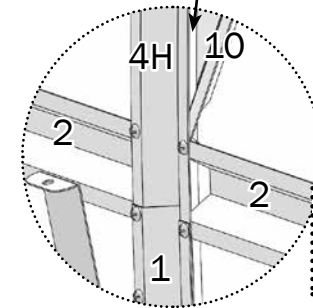
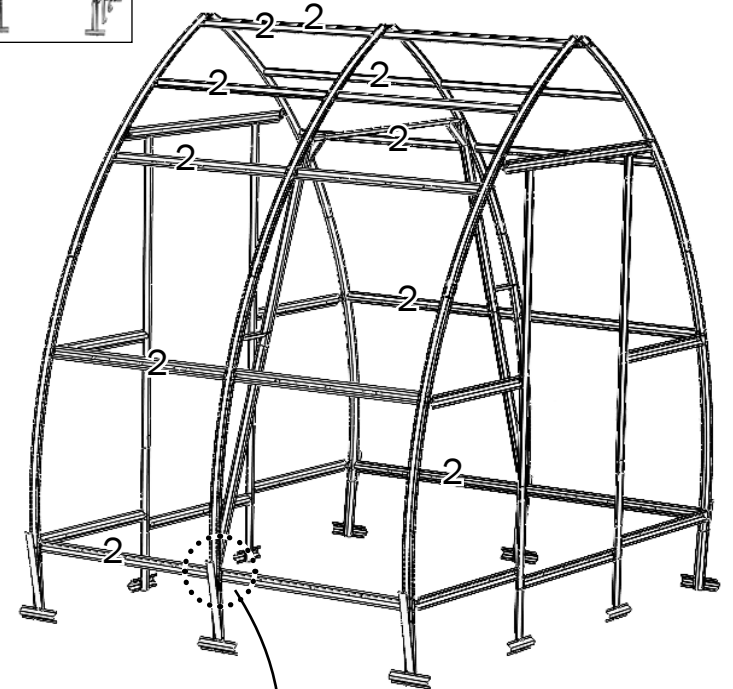
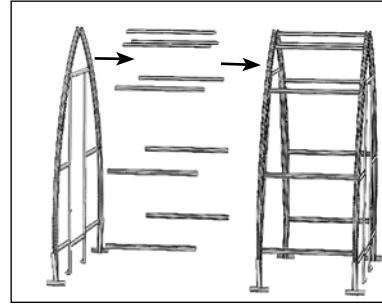

No6   x2  
M5x10 M5

# 4.3

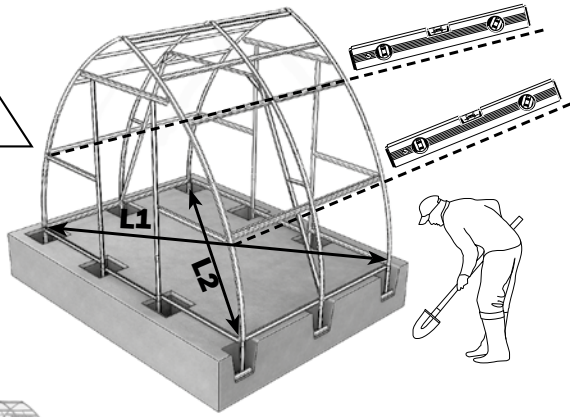

# 4.4

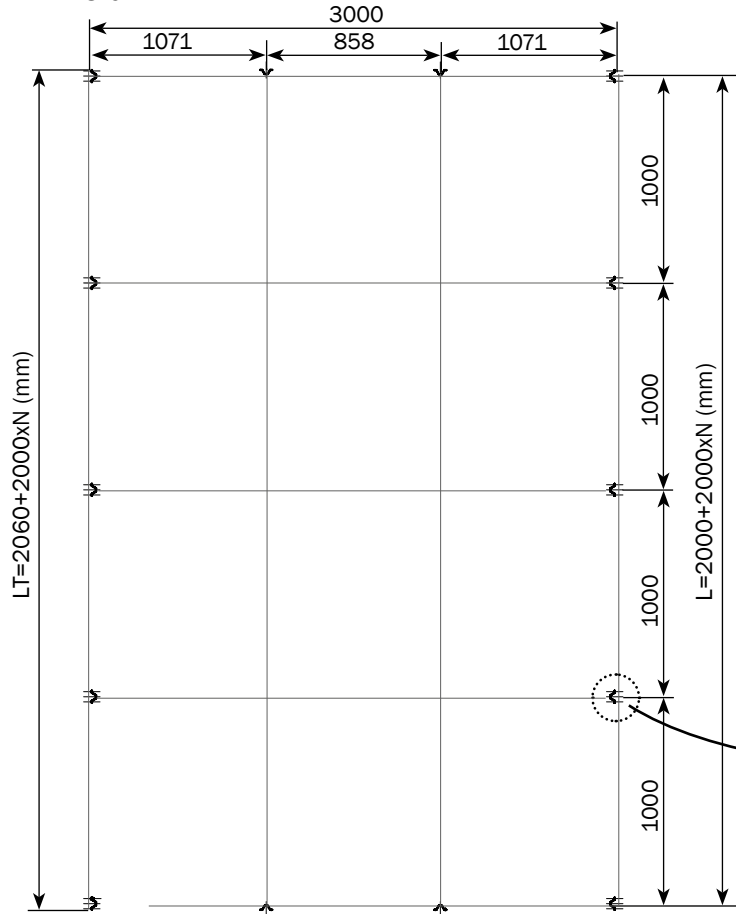
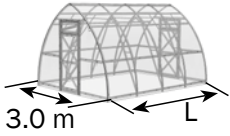

# 4.5

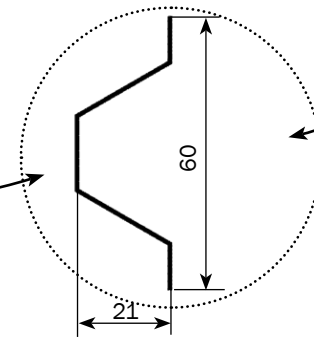
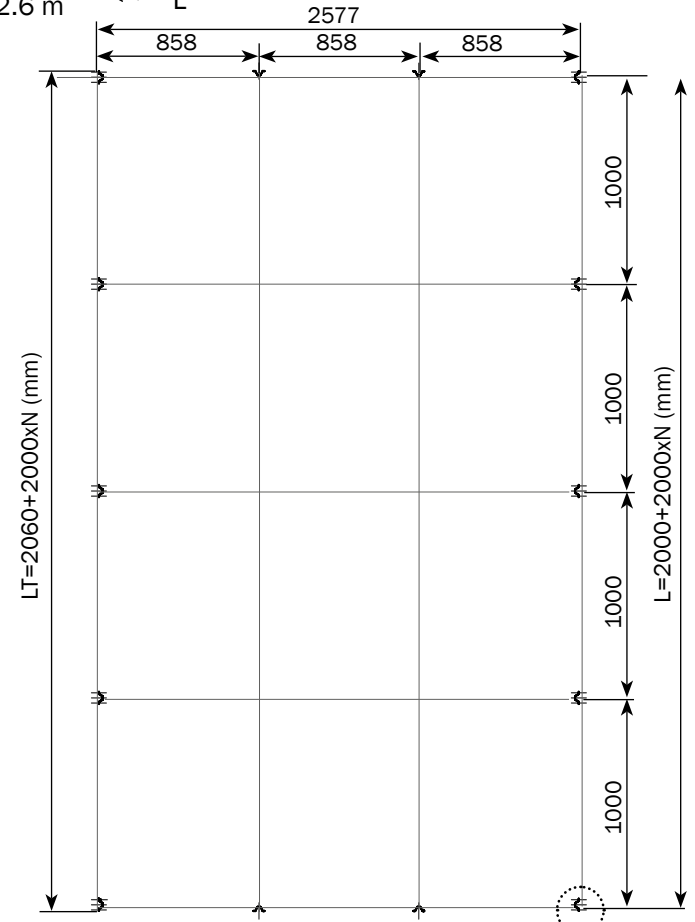
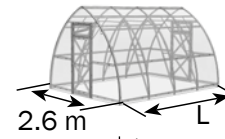

# 5.1

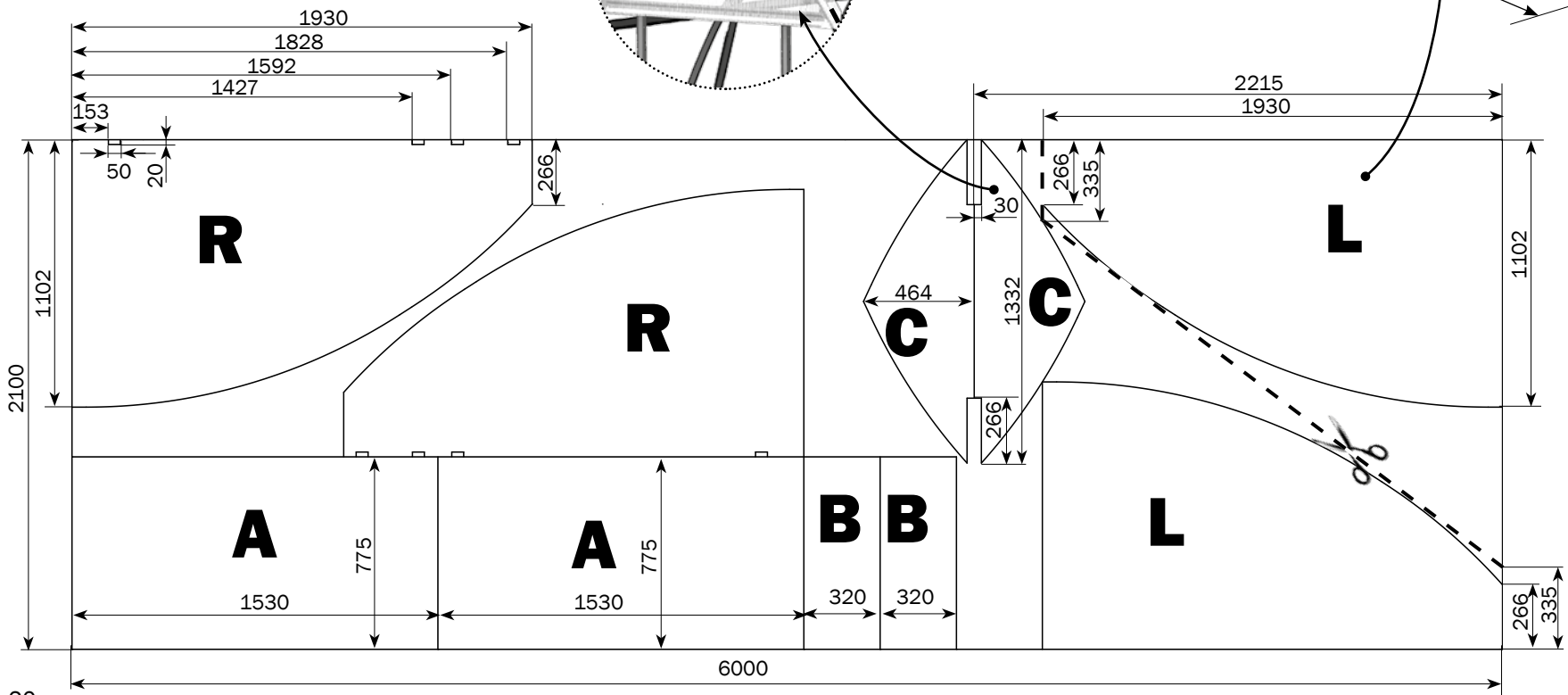
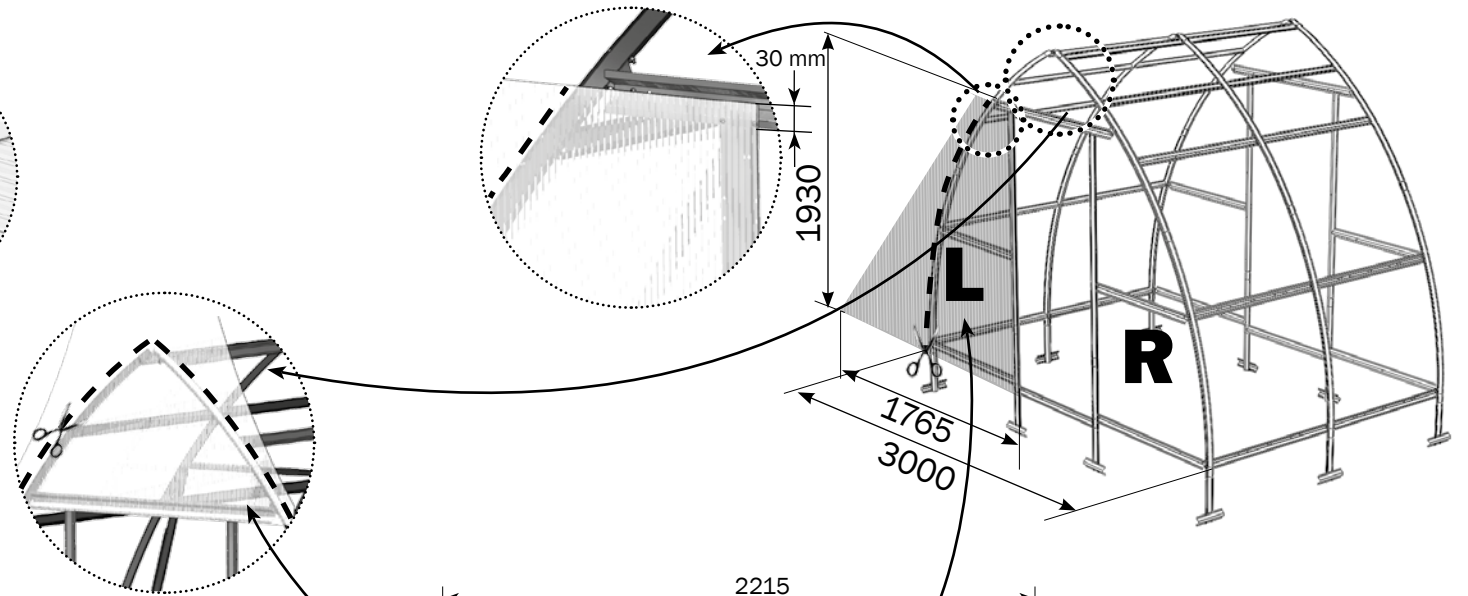
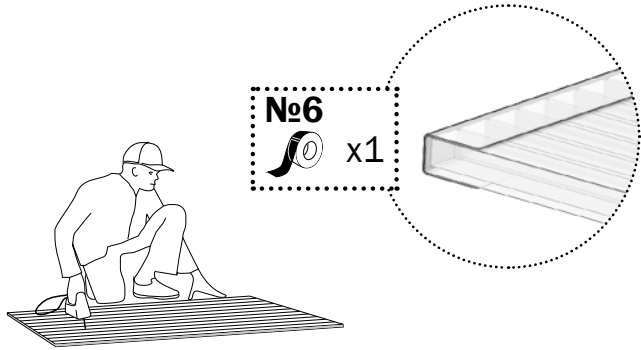
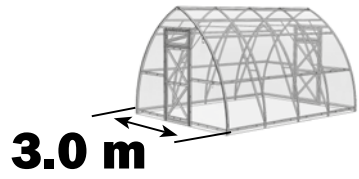

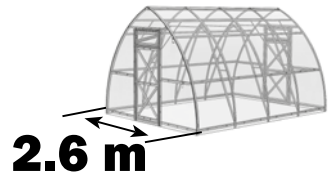

# 5.2



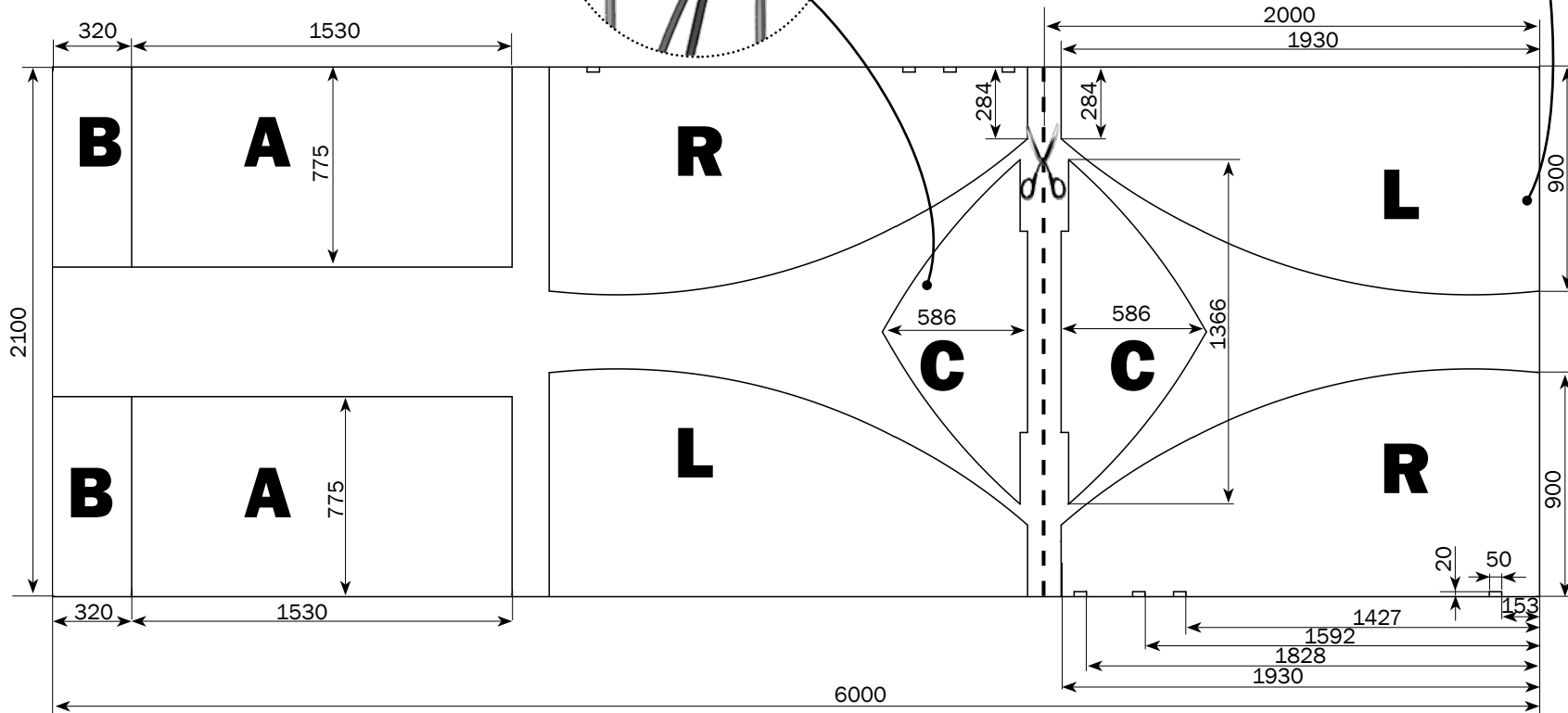
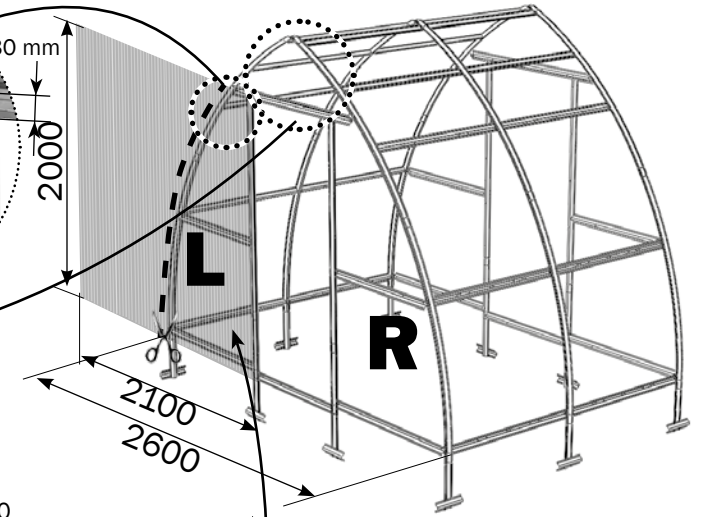
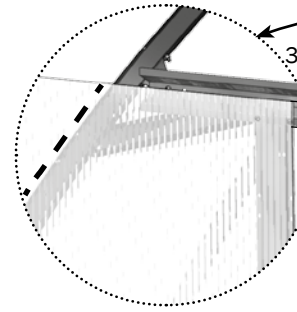
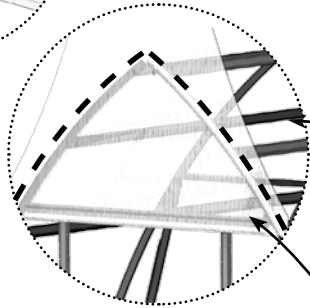
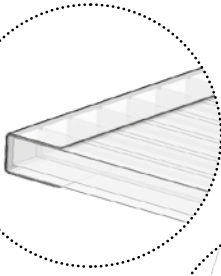
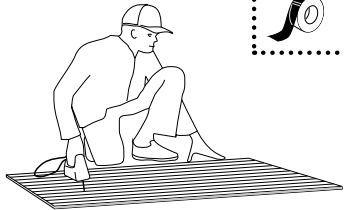



№6  
x1



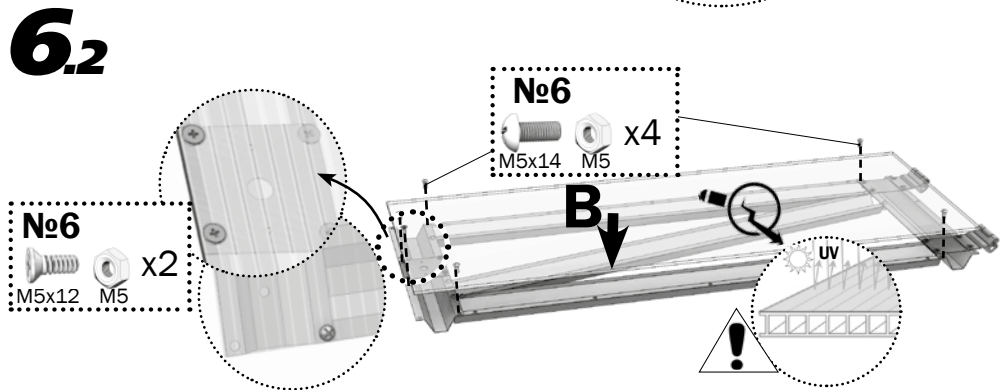
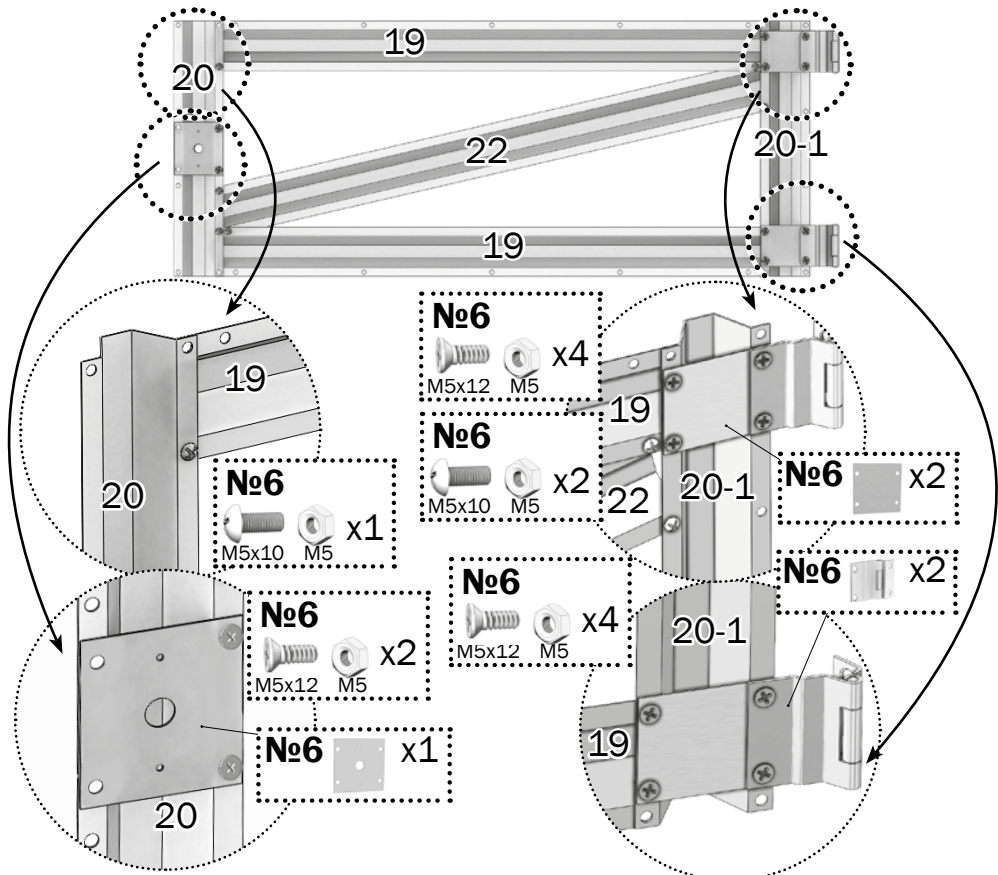

**6.1** №1  x1    №1  x1    №1  x2

№1  x1



**6.3** №4  x2    №4  x1    №4  x1

№6  x17     x17

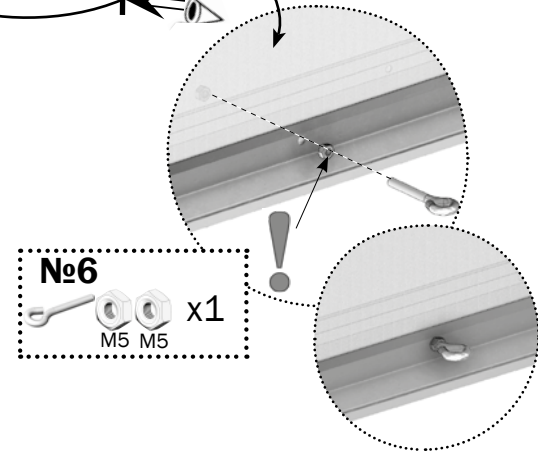
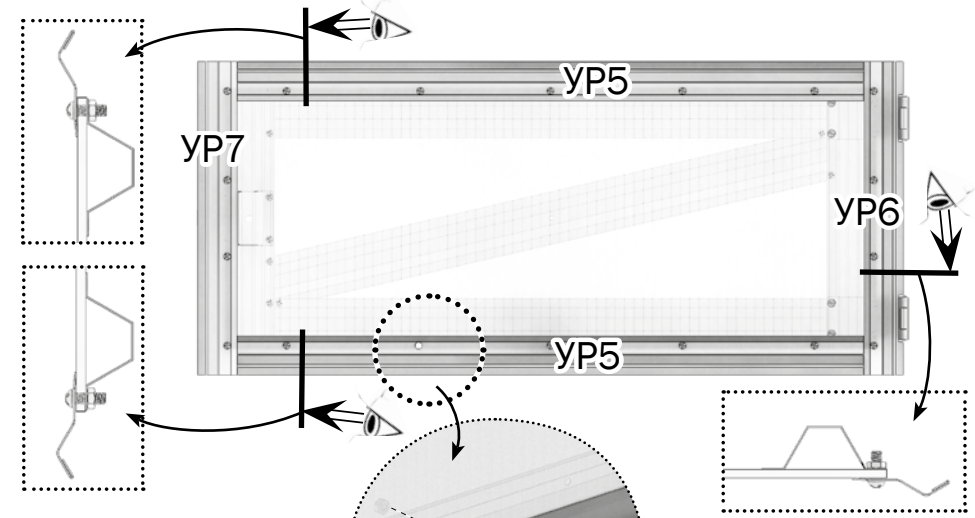
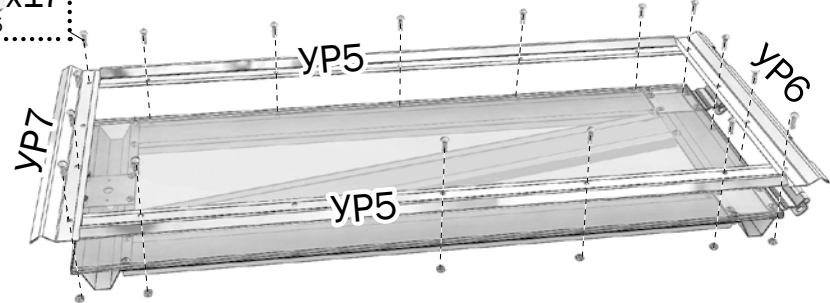

**X2**

# 7.1

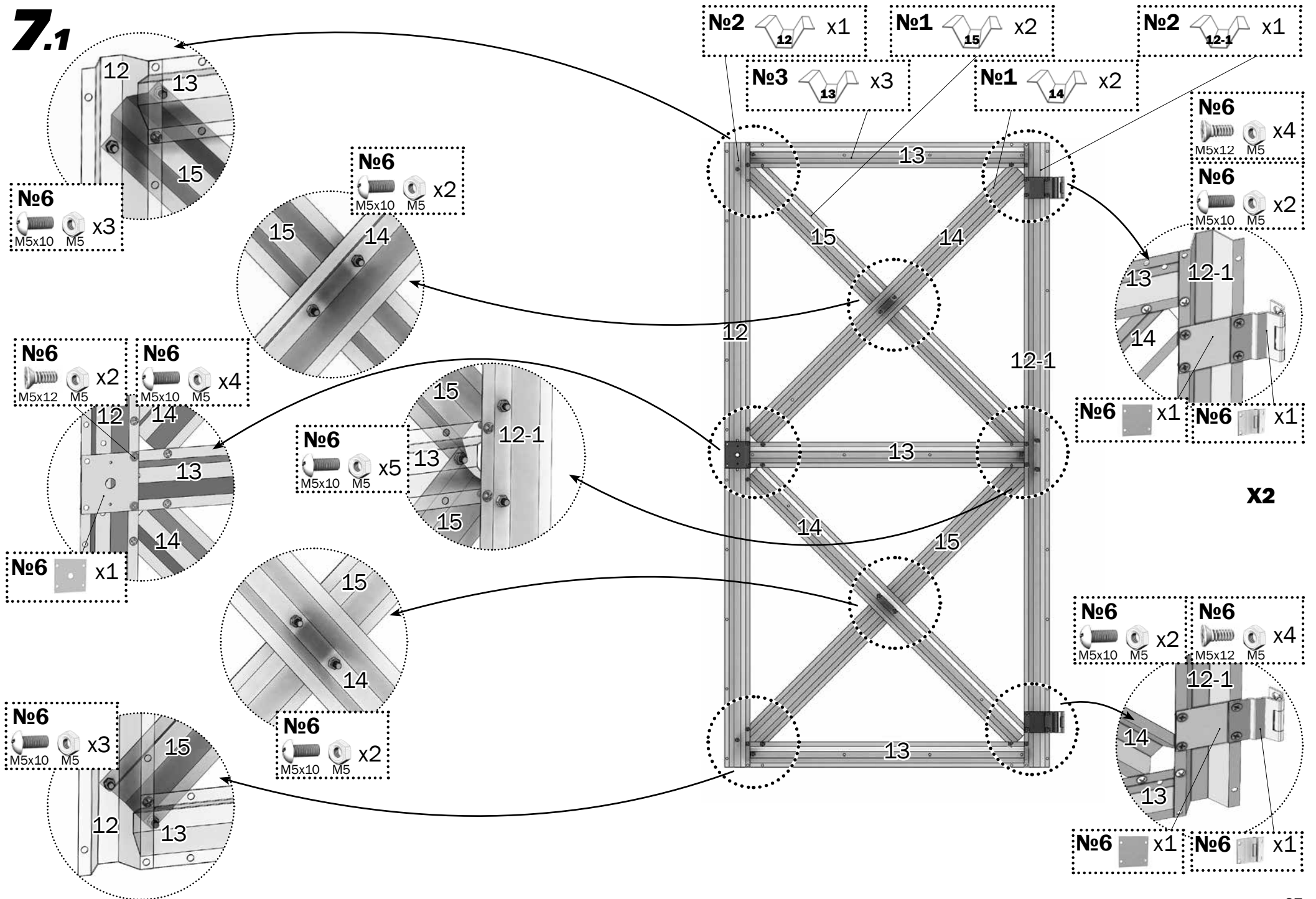

# 7.2

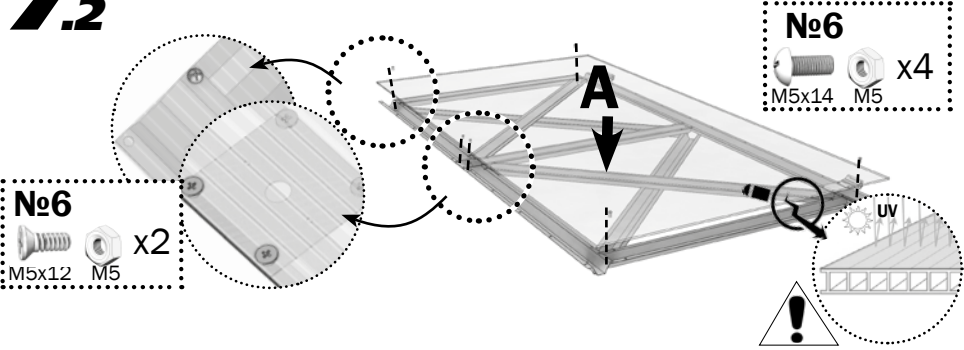

# 7.3

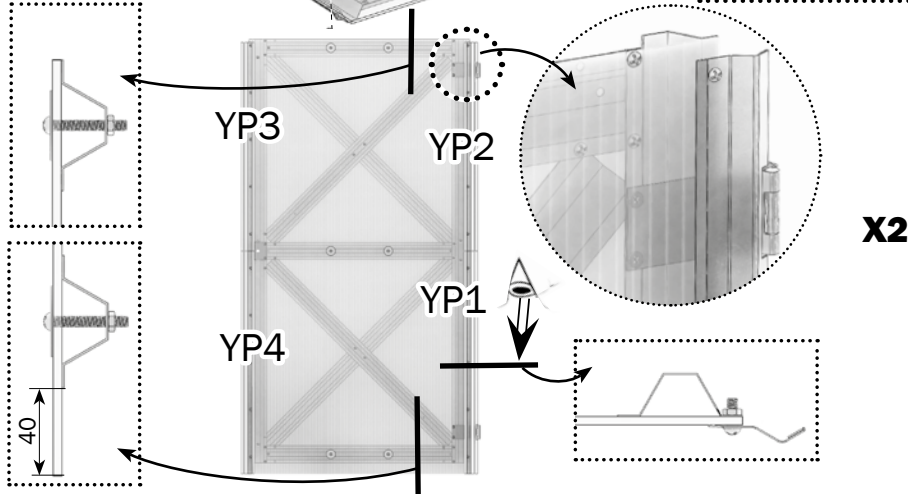
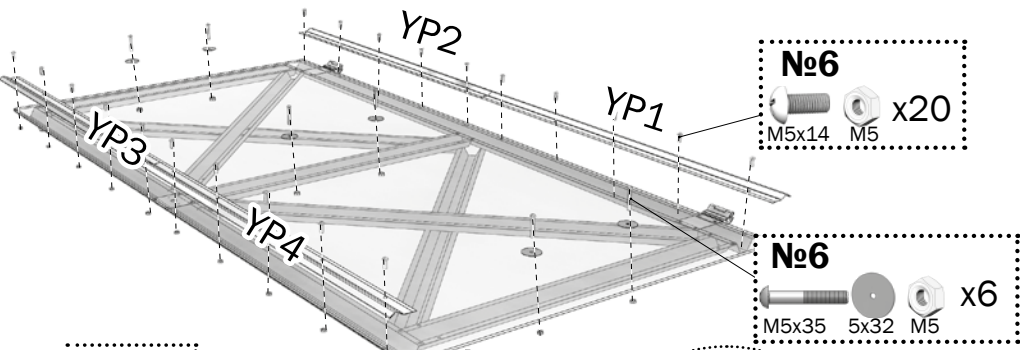
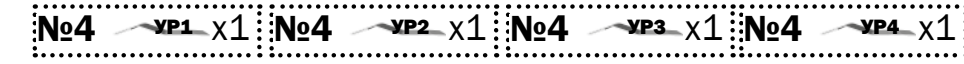

# 8.1

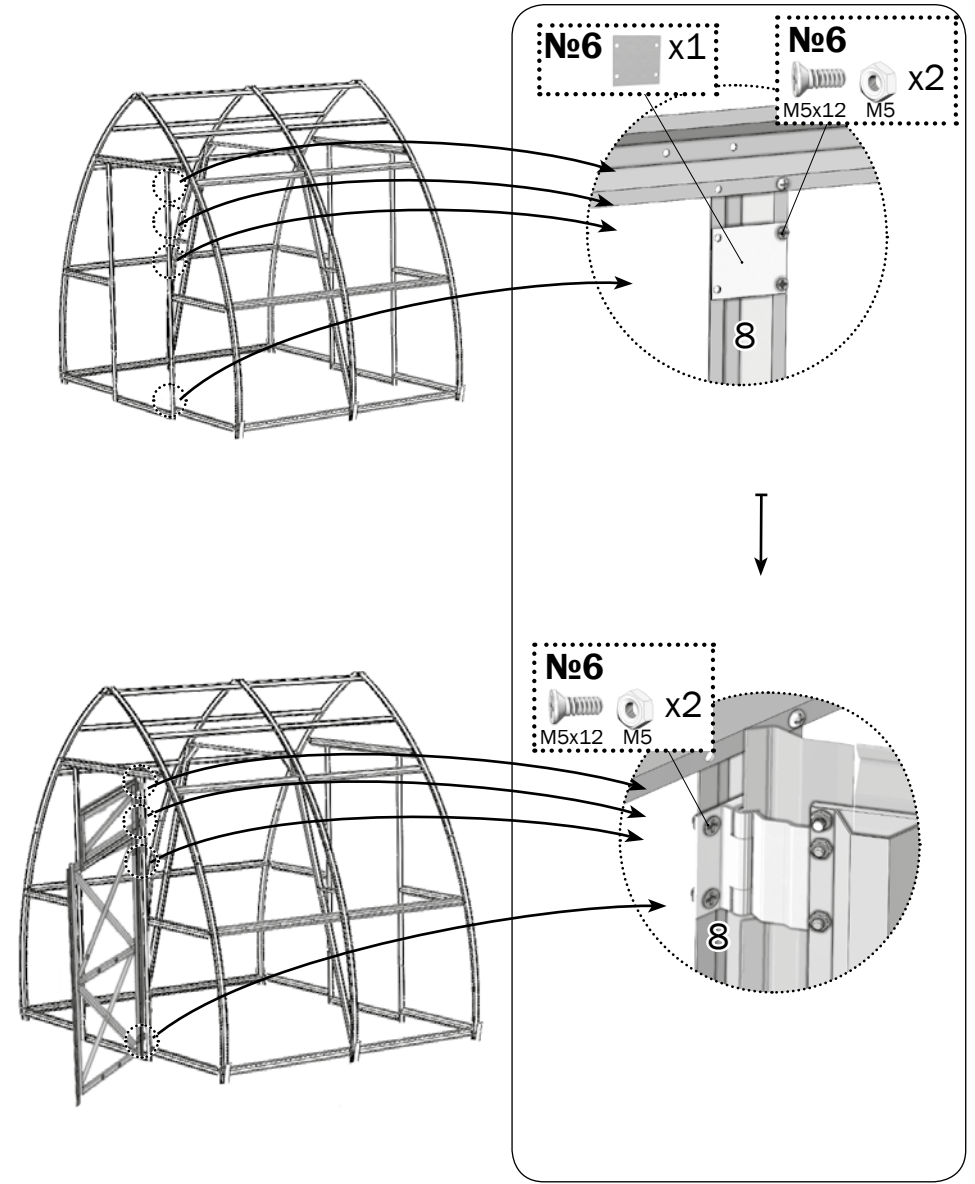

# 8.2

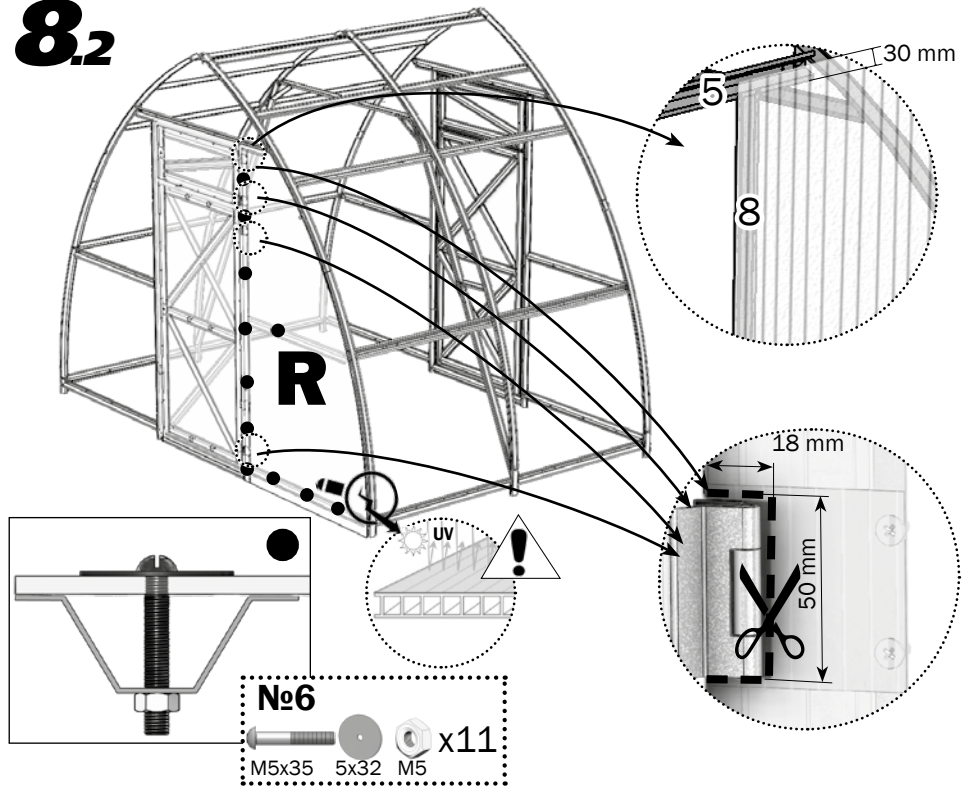

# 8.3

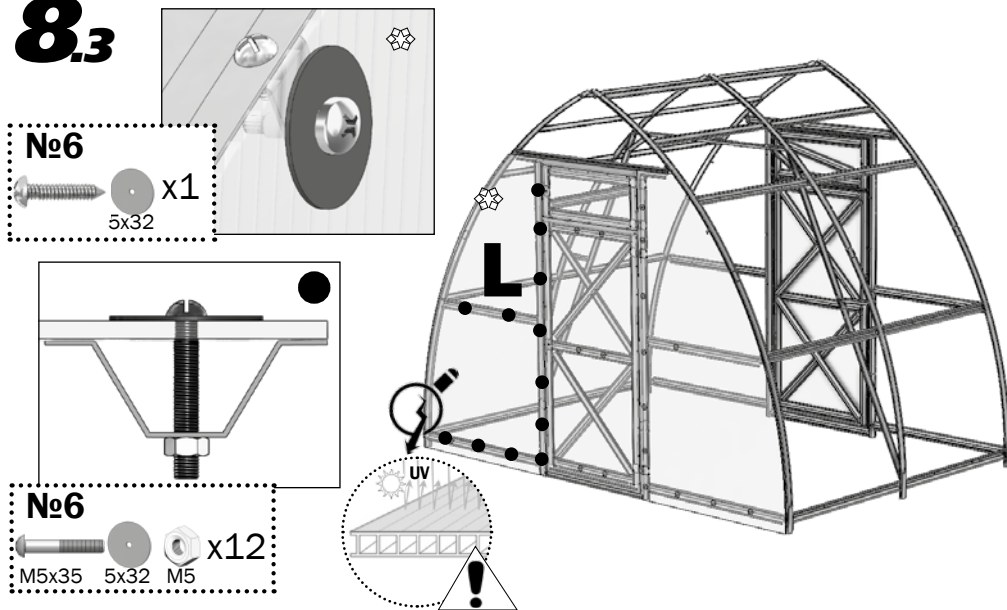

# 8.4

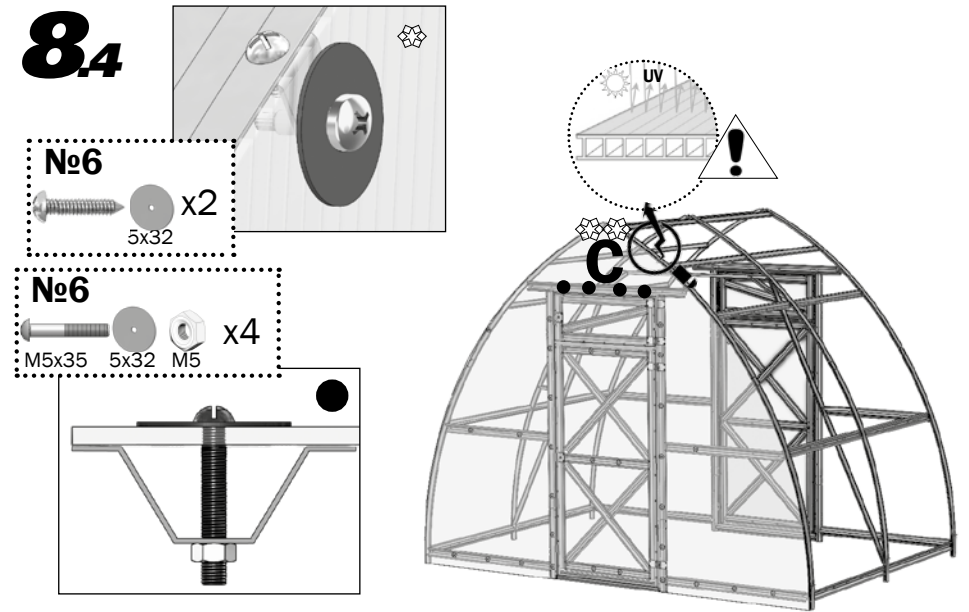

# 8.5

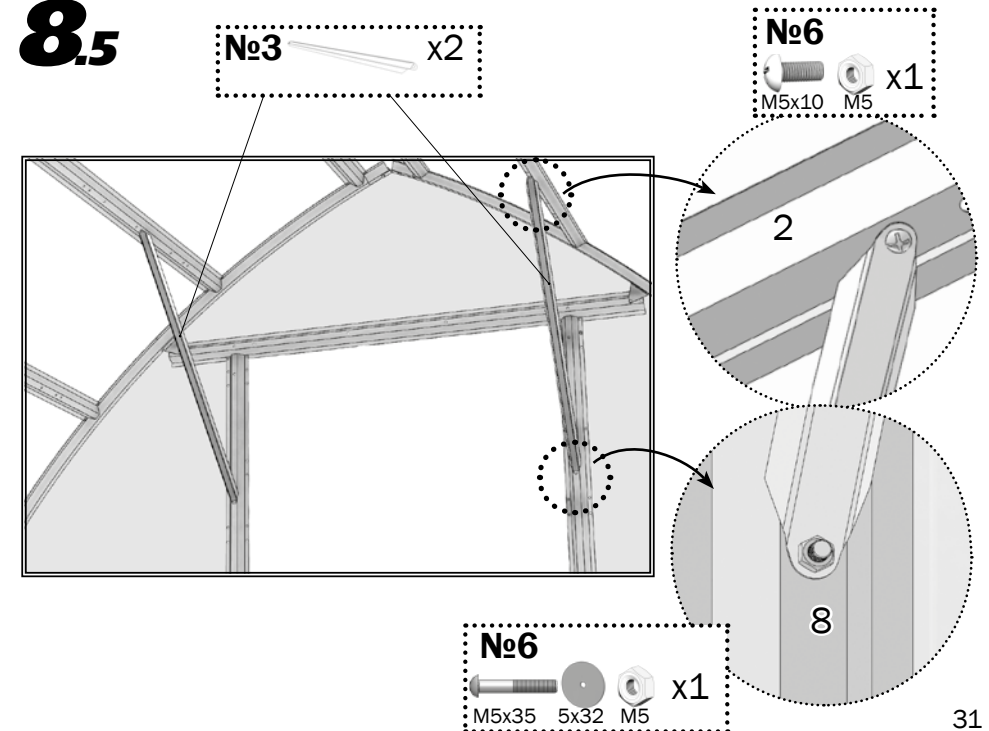



# 9

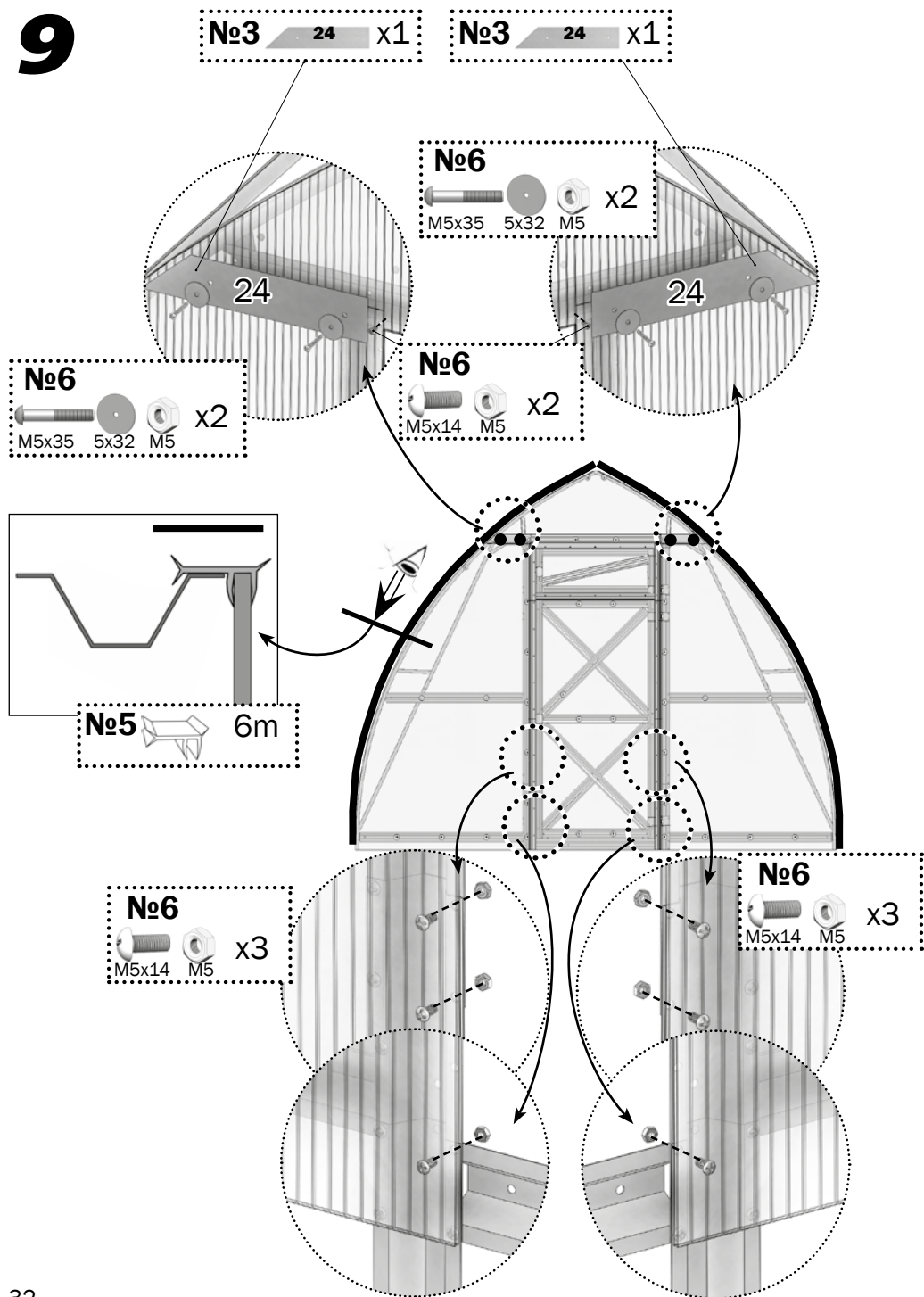

# 10

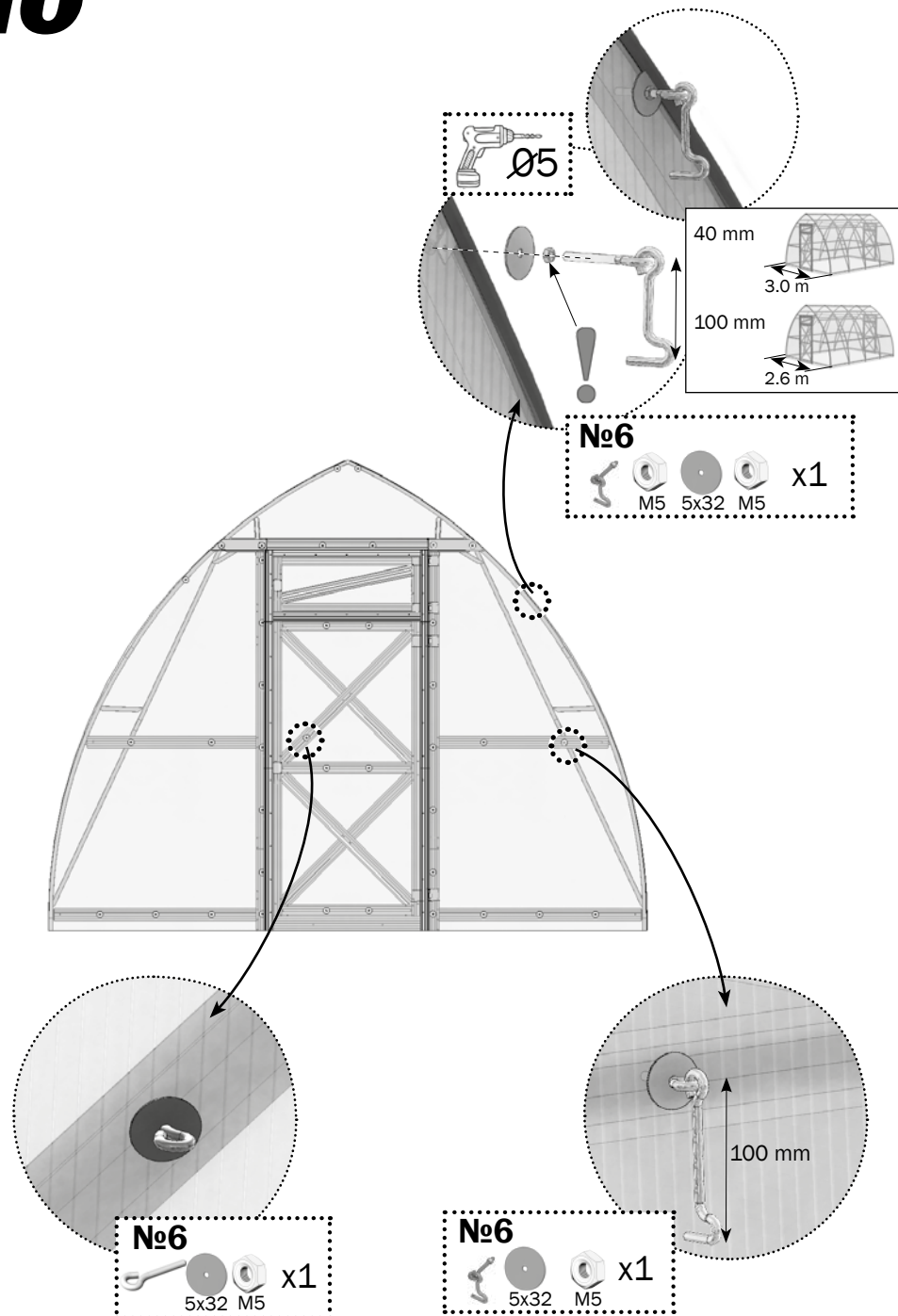

# 11

№4  x2

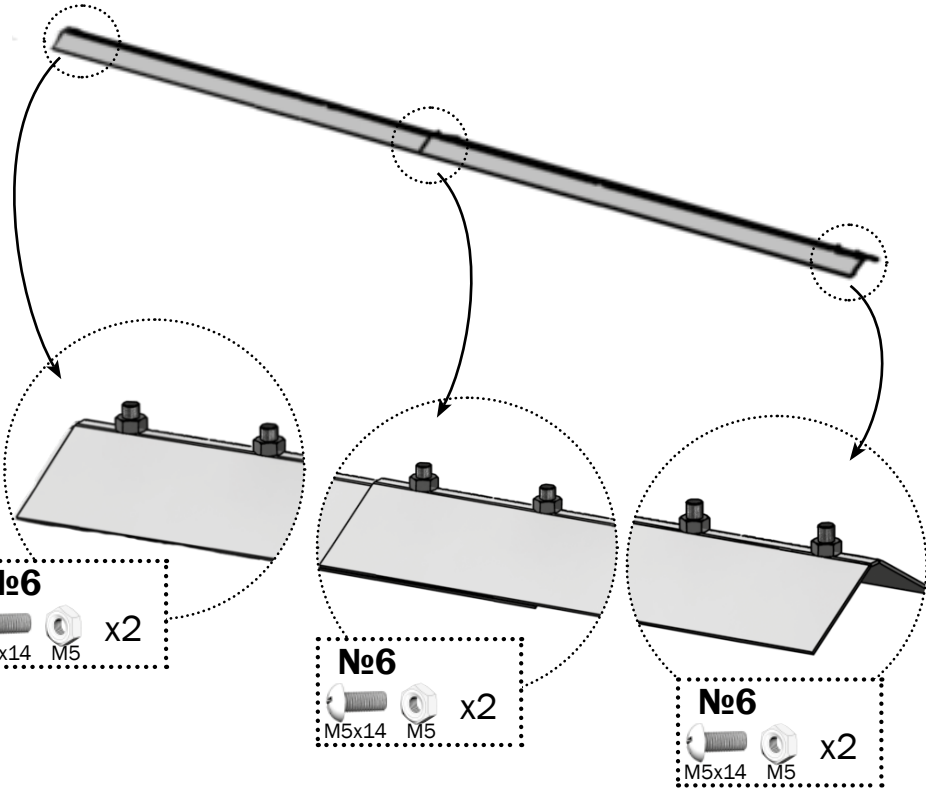

# 12

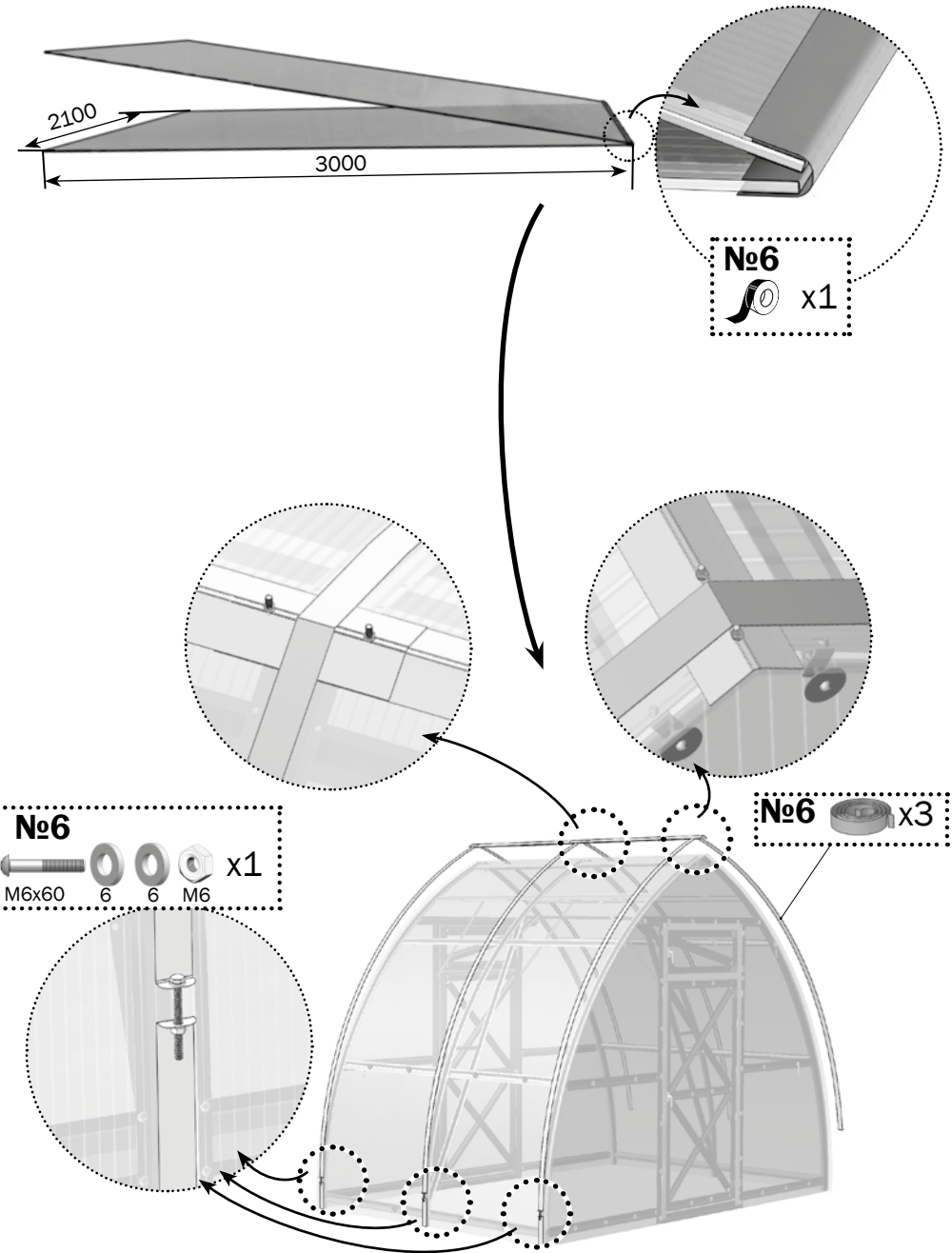

# 13

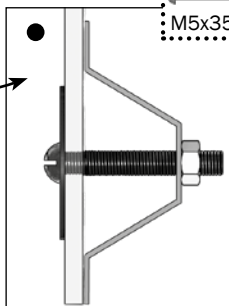
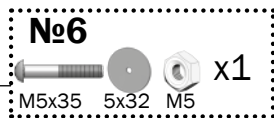
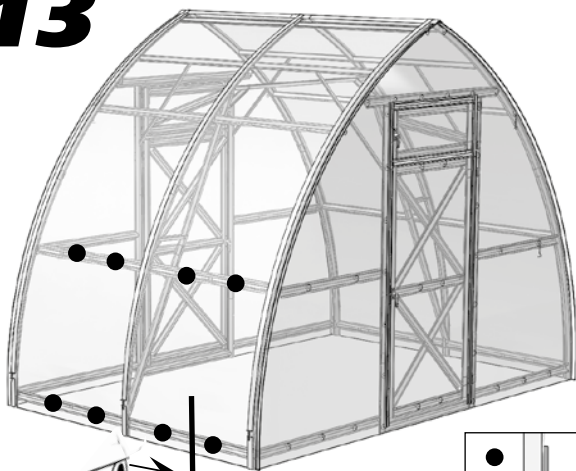

# 14

